

HIT[®] photovoltaic module

HIT-240HDE4 HIT-235HDE4

The SANYO HIT[®] (Heterojunction with Intrinsic Thin layer) solar cell is made of a thin mono crystalline silicon wafer surrounded by ultra-thin amorphous silicon layers. This product provides the industry's leading performance and value using state-of-the-art manufacturing techniques.

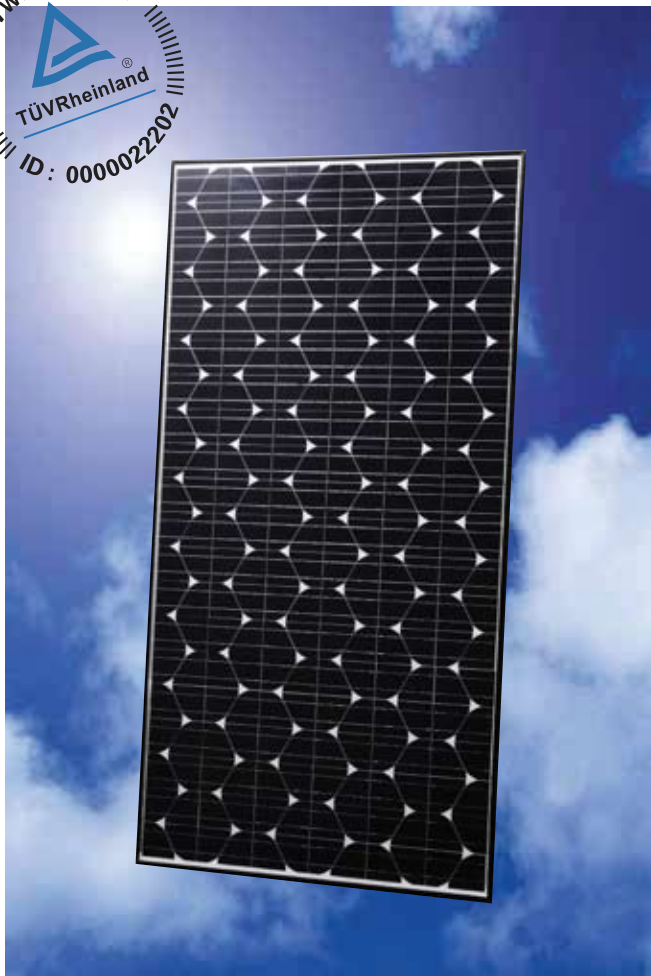

Benefit in Terms of Performance

The HIT[®] cell and module have very high conversion efficiency in mass production.

Model	Cell Efficiency	Module Efficiency
HIT-240HDE4	20.0%	17.3%
HIT-235HDE4	19.6%	16.9%

High performance at high temperatures

Even at high temperatures, the HIT[®] solar cell can maintain higher efficiency than a conventional crystalline silicon solar cell.

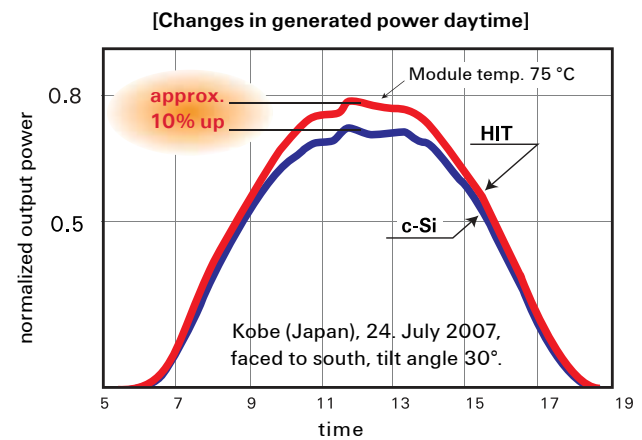

HIT[®] Solar Cell Structure

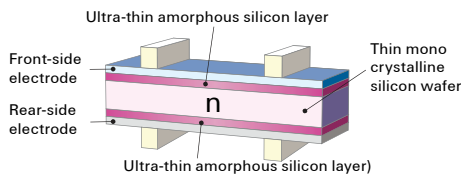

Development of HIT[®] solar cell was supported in part by the New Energy and Industrial Technology Development Organization (NEDO).

Environmentally-Friendly Solar Cell More Clean Energy

HIT[®] can generate more clean Energy than other conventional crystalline solar cells.

A module that uses silicon resources effectively

The newly developed "Honeycomb Design" HD cell allows the maximum number of round-type, high-power cells to be arrayed in a single module.

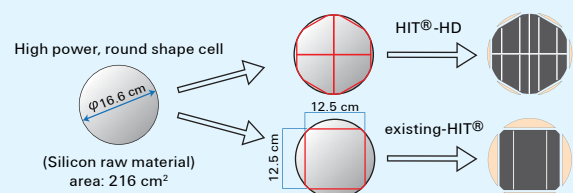

Models HIT-xxxHDE4		
Technical data	240	235
Maximum power (Pmax) [W]	240	235
Max. power voltage (Vpm) [V]	35.5	35.1
Max. power current (Ipm) [A]	6.77	6.70
Open circuit voltage (Voc) [V]	43.6	43.4
Short circuit current (Isc) [A]	7.37	7.33
Warranted min. power (Pmin) [W]	228.0	223.3
Maximum over current rating [A]	15	
Output power tolerance [%]	+ 10/-5	
Max. system voltage [Vdc]	1000	
Temperature coeff. of Pmax [%/°C]	-0.30	
Temperature coeff. of Voc [V/°C]	-0.109	-0.109
Temperature coeff. of Isc [mA/°C]	2.21	2.20
Note 1: Standard test conditions: Air mass 1.5, Irradiance = 1000 W/m ² , Cell temperature = 25 °C.		
Note 2: The values in the above table are nominal.		

Reference data for model HIT-240HDE4

Dependence on irradiance

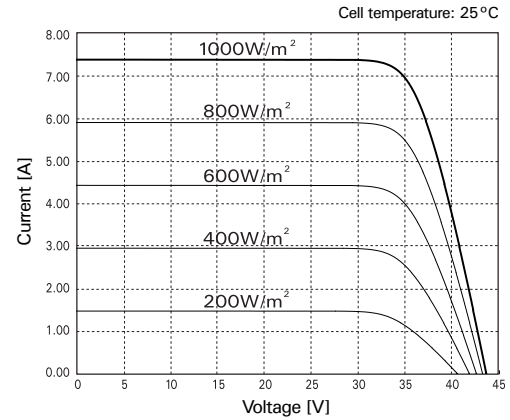

Dependence on temperature

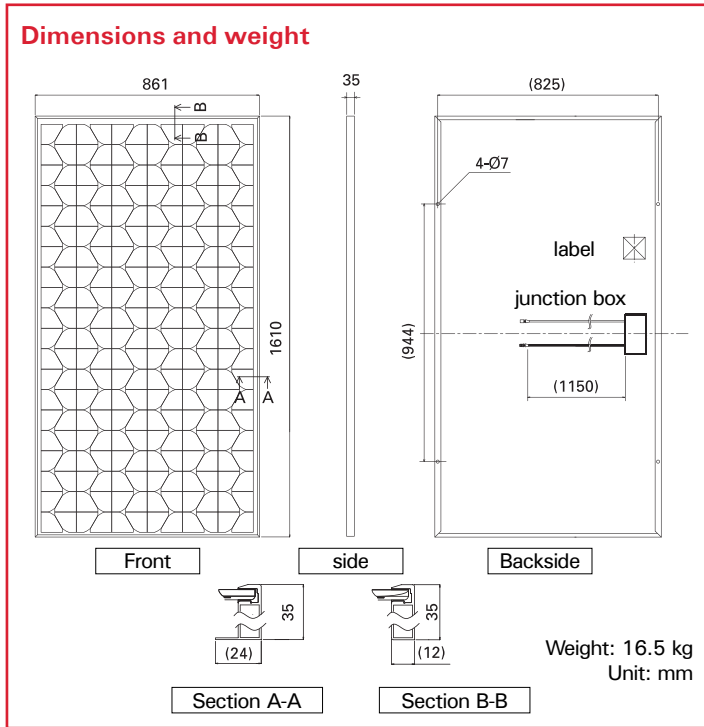
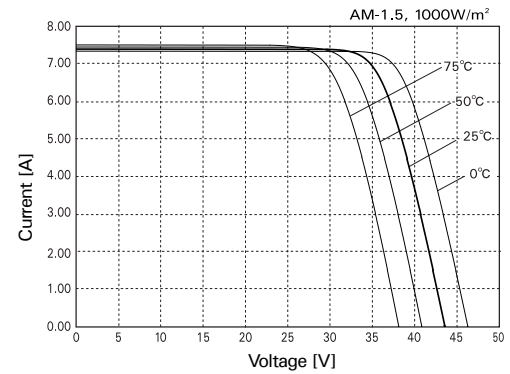

Certificates

IEC 61730 IEC 61215



- Qualified, IEC 61215
- Safety tested, IEC 61730
- Periodic Inspection



Electrical Protection Class II

Please consult your local dealer for more information.

CAUTION! Please read the operating instructions carefully before using the products.

Due to our policy of continual improvement the products covered by this brochure may be changed without notice.

SANYO Component Europe GmbH
Solar Division

Stahlgruberring 4
81829 Munich, Germany
Tel. +49-(0)89-460095-0
Fax. +49-(0)89-460095-170
<http://www.sanyo-solar.eu>
email: info.solar@sanyo-solar.eu



SANYO Electric Co., Ltd.
Solar Division

<http://www.sanyo.com/solar>
email: homepage_solar@sanyo.com